



EXTRACTORES DE INTERIORES SERIE 43 INTERNAL PULLERS SERIE 43



Manual de instrucciones *Manual instructions*



ES

MI43
Rev. 2 - 23.12.2022



EN

Contacto: ventas@forza.es / www.forza.es

Características / Characteristics

Extractores para interiores. / *Internal puller.*

Tipo pinza elástica. / *Elastic type collet.*

Abarca todo el arco del rodamiento con sus múltiples cortes desde dos en las pinzas muy pequeñas hasta seis en las más grandes. / *It covers the entire arc of the bearing with its multiple cuts from 2, in the very small collets, to six in the largest.*

Fabricadas en material CrVa. / *Made of CrVa material.*

Los husillo de presión a partir de la pinza 4320 llevan un punto postizo templado a 55HRC para que las pinza abran más suavemente. / *From the 4320 collet, the pressure spindle has an insert point, hardened at 55HRC. Thus, the collets can be opened smoothly.*

Con dos sistemas para la extracción / *With two extraction system:*

- Barra de impacto / *Slide hammer*
- Puente con patas / *Push puller with jaws*

Se adaptan a ambos extractores directamente sin necesidad de adaptadores / *They can be directly adapted to both pullers without any adapter*

Dimensiones del extractor / Puller dimensions



4305-4308

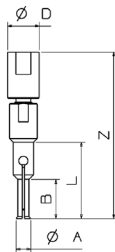

Resto de modelos

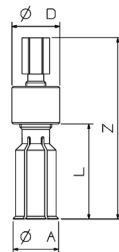

Ref.	ØA min.	ØB min.	B	L	Z	ØD	Peso
4305	5	7	8	27	82	15	0,08
4308	8	11	20	40	90	15	0,09
4312	12	14	-	64	108	33	0,27
4315	15	119	-	64	125		0,27
4320	20	24	-	65	125		0,32
4325	25	29	-	65	125		0,37
4330	30	37	-	65	125		0,42
4338	38	46	-	65	125		0,55
4347	47	54	-	88	175	45	1,32
4355	55	64	-	89	175		1,58
4365	65	76	-	89	175		1,95

Instrucciones / Instructions



**NO ES RECOMENDABLE USAR
LLAVES DE IMPACTO / IT IS
NOT RECOMMENDED TO USE
POWER TOOLS**

- 1- Engrase los husillos. / *Make sure the spindle is cleaned and greased before use.*
- 2- Elegir la pinza adecuada a la pieza a extraer. Elegir siempre el modelo mayor posible. / *Choose the right collet according to the part to be extracted. Choose always the largest model as possible.*
- 3- Introducir la pinza en el agujero sin llegar al fondo, tensar el husillo ligeramente. / *Insert the collet into the hole without reaching the bottom. Tighten the spindle slightly.*
- 4- Seguir introduciendo la pinza hasta que llegue al radio del rodamiento. Se notará un click y que la pinza se afloja. / *Continue inserting the collet until it reaches the bearing radius. You will notice a click and the collet starts to loosen.*
- 5- Volver a abrir la pinza lo máximo posible girando el husillo. / *Re-open the collet as much as possible by turning the spindle.*
- 6- Tirar de la pinza con el contra apoyo 4392 o con la barra de impacto 4390. / *Pull out the collet with the 4392 push puller or with the 4390 slide hammer.*

Instrucciones de extracción

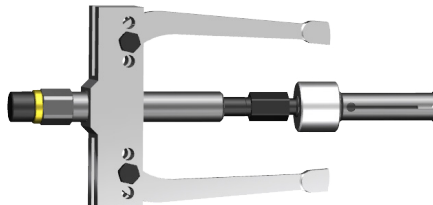
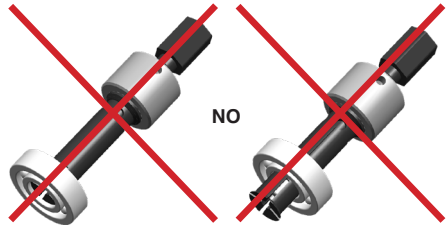
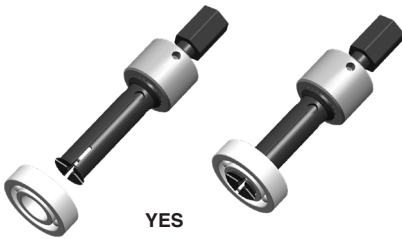

Despiece del extractor / Puller spare part

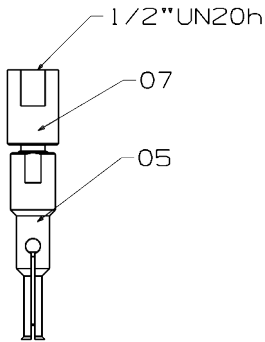

4305 - 4308



Adaptador / Adapter

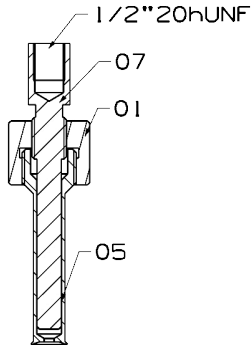

4305 - 4308



Pinza / Collet

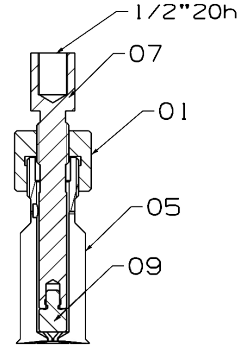

4320 - 43665



Husillo / Spindle

El husillo de las pinzas de la 4320 a la 4365 tiene un punto postizo giratorio para suavizar la apertura de la pinza. El husillo completo se codifica como 30. Por ejemplo el husillo 432030 es la suma del husillo suelto 432007 más el punto 432009.

The collets' spindles which are greater than 4320, have a swivel point, to improve the opening of the collet. The completed spindle reference is 432030. This reference includes the spindle 432007 and the point 432009

Ref.	Peso	Pinza	Cazoleta	Husillo
4305	0,08	430505	no	430507
4308	0,09	430805	no	430807
4312	0,27	431205	431201	431207
4315	0,27	431505		431207
4320	0,32	432005		432030
4325	0,37	432505		
4330	0,42	433005		
4338	0,55	433805		
4347	1,32	434705		434701
4355	1,58	435505		
4365	1,95	436505		

Barras de impacto / Slide hammer

La más común para estas pinzas es la barra de impacto de 1Kg, ref. 4390. / *The slide hammer of 1kg (4390) is the most common for these type of collets*

Rosca a todas las pinzas sin necesidad de adaptadores. / *Can be assembled with all the collets without any adapter*

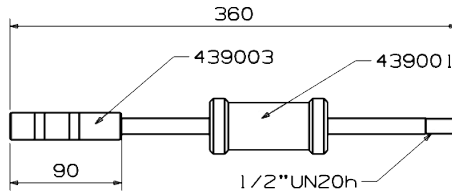

Se puede montar una barra de impacto de 2Kg de masa, ref. 4394, para trabajar con más fuerza de extracción. / *It is possible to assemble the slide hammer of 2 kg (4394) in order to work with higher extraction force.*

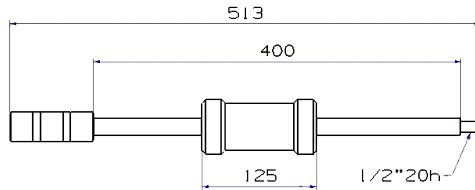

Esta barra se puede montar en posición corta si fuera necesario. / *If it is necessary, this bar can be mounted in the short position.*

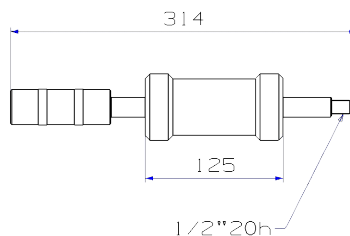
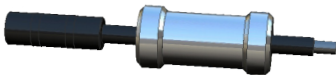

Puente extractor 4392 / 4392 Push puller

En este puente se pueden roscar todas las pinzas sin usar adaptadores.

All collets can be assembled in this push puller without any adapter.

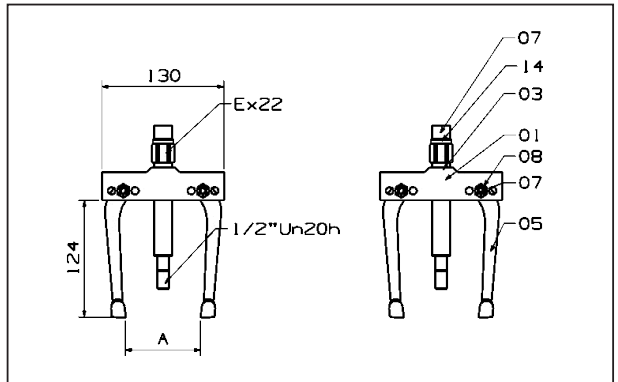

Prolongadores para las pinzas (no incluidas) / *Externder for the collets (not included)*

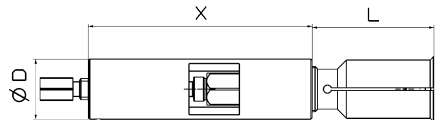
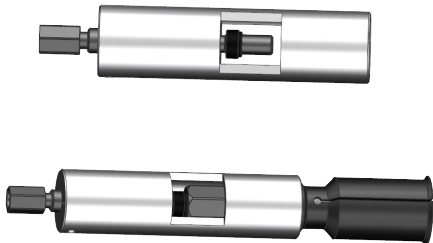

Ref.	ØD	X	Peso
431250	33	150	0,14
434750	45	170	0,16

El prolongador 431250 es para las pinzas de la 4312 a la 4338. / *The 431250 extension is for collets from 4312 to 4338*

El prolongador 4347 es para las pinzas de la 4347 a la 4365. / *The 434750 extension is for collets from 4347 to 4365.*

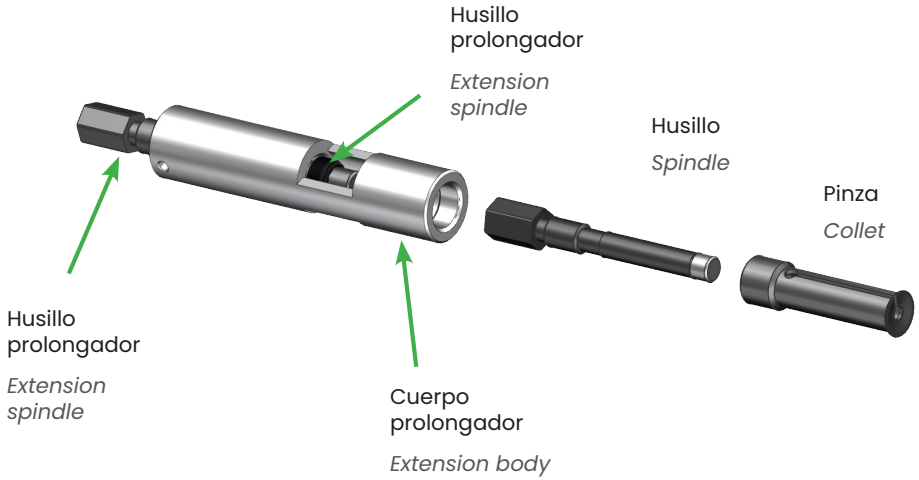

1

Montar la pinza enroscándola al prolongador. / *Mount the collet by screwing it to the extension*

Fijar la rosca apretando la tuerca contra el husillo. / *Fix the thread by tightening the nut against the spindle.*

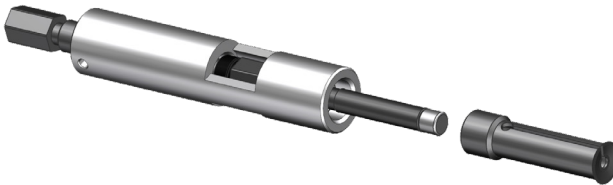

2

Ya estaría listo para su uso.
It is ready for use.

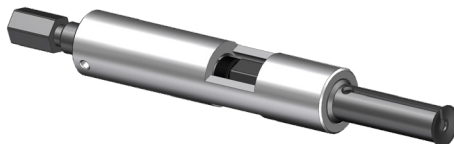



S.L. de Herramientas Especiales Forza
San Miguel de Acha, 24
010110 Vitora-Gasteiz (España)
Tlf.: 945 24 97 16